



Low Cost ±1.7 g Dual-Axis Accelerometer with Ratiometric Outputs

MXR7993VF

FEATURES

Dual axis accelerometer fabricated on a single CMOS IC
Monolithic design with mixed mode signal processing

On-chip sensitivity compensation for temperature variations
On Demand Self Test

±1.7g dynamic range, 660mV/g sensitivity
Independent axis programmability (special order)
Resolution better than 1mg

Zero-g Output Temperature drift, better than ±100mg over
-40~105°C range

27 Hz bandwidth
>50,000 g shock survival rating
3.0V to 3.6V single supply operation
Small surface mount package, 5mm x 5mm x 2mm

APPLICATION

Automotive – Roll over sensing systems

GENERAL DESCRIPTION

The MXR7993VF is a low cost, dual axis accelerometer built on a standard, submicron CMOS process. It measures acceleration with a full-scale range of ±1.7g and a sensitivity of 660mV/g.

The MXR7993VF provides a g-proportional ratiometric analog output above/below the zero-g point at 50% of the supply voltage.
(Ref. other MEMSIC data sheets for absolute analog or digital outputs).

The typical noise floor is $0.6\text{mg} / \sqrt{\text{Hz}}$, allowing signals below 1 mg to be resolved at 1Hz bandwidth. The 3dB roll-off of the device occurs at 27Hz.

The MXR7993VF is available in a low profile LCC surface mount package (5mm x 5mm 2mm). It is hermetically sealed and operational over a -40°C to +105°C temperature range.

MEMSIC's accelerometer technology allows for designs from ±1 g to ±70 g with custom versions available above

Information furnished by MEMSIC is believed to be accurate and reliable. However, no responsibility is assumed by MEMSIC for its use, nor for any infringements of patents or other rights of third parties, which may result from its use. No license is granted by implication or otherwise under any patent or patent rights of MEMSIC.

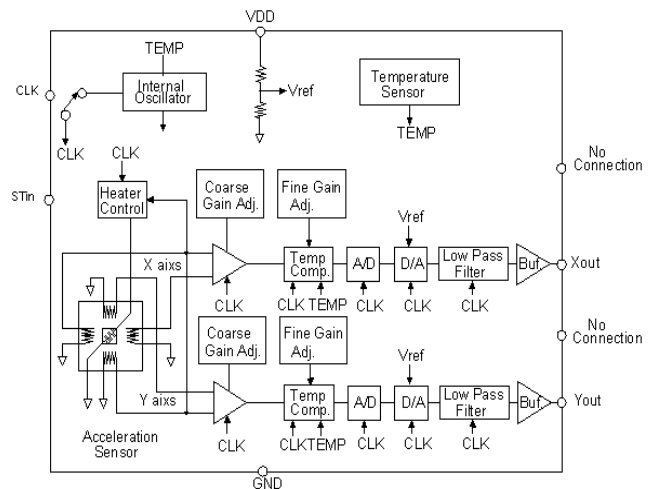

MXR7993VF FUNCTIONAL BLOCK DIAGRAM

±70 g. It can measure both dynamic acceleration (e.g., vibration) and static acceleration (e.g., gravity). The design is based on heat convection and requires no solid proof mass. This eliminates stiction and particle problems associated with competitive devices and provide shock survival greater than 50,000 g, leading to significantly lower failure rates and lower loss due to handling during assembly and at customer field application. Due to the standard CMOS structure of the MXR7993VF, additional circuitry can easily be incorporated into custom versions for high volume applications. Contact Memsic's local office for more information.

©MEMSIC, Inc.
One Technology Drive, Suite 325, Andover, MA01810, USA
Tel: +1 978 738 0900 Fax: +1 978 738 0196
www.memsic.com

MXR7993VF SPECIFICATIONS (Measurements @ 25°C, Acceleration = 0 g unless otherwise noted; V_{DD} = 3.3V unless otherwise specified)

Parameter	Conditions	MXR7993VF			Units
		Min	Typ	Max	
SENSOR INPUT	Each Axis	1.7g			g
Measurement Range ¹					
Non linearity	Best fit straight line		1.0	2.0	% of FS
Alignment Error ²			±0.5		degrees
Transverse Sensitivity ³			±0.5		%
SENSITIVITY	Each Axis				
Sensitivity, Analog Outputs at pins Xout and Yout ⁴			660		mV/g
Change over Temperature	Δ from 25°C, -40°C to +105°C	-6		+6	%
+1g BIAS LEVEL	Each Axis				
+1g Offset		-0.15	0.00	+0.15	g
+1g Voltage			1.65		V
+1g Offset over Temperature	Δ from 25°C, -40°C to +105°C based on 660mV/g			±100	mg
NOISE PERFORMANCE					
Noise Density, rms			0.6		mg/√Hz
FREQUENCY RESPONSE					
3dB Bandwidth		24	27	30	Hz
Xout and Yout OUTPUTS					
Normal Output Range (Guaranteed symmetric clipping)		0.5		2.7	V
Turn-On Time			150		mS
POWER SUPPLY					
Operating Voltage Range		3.0	3.3	3.6	V
Supply Current			6		mA
TEMPERATURE RANGE					
Operating Range		-40		+105	°C
PRESSURE RANGE					
Operating Range		40		300	KPa.

NOTES

¹ Guaranteed by measurement of initial offset and sensitivity.

² Alignment error is specified as the angle between the true and indicated axis of sensitivity.

³ Transverse sensitivity is the algebraic sum of the alignment and the inherent sensitivity errors.

⁴ The device operates over a 3.0V to 3.6V supply range. The output zero g reference voltage scales 50% of the supply voltage. Sensitivity has a linear scale over the supply range of 3.0 to 3.6 volts according to the ratio (V_{DD}/3.3 volts) x (660mV/g).

recommended to filter with a minimum of 200Hz low pass filter.

⁵ Note that the accelerometer has a constant heater power control circuit thereby requiring higher supply current at lower operating voltage.

ABSOLUTE MAXIMUM RATINGS*

Supply Voltage (V_{DD} , V_{DA})¹-0.5 to +7.0V
 Storage Temperature-70°C to +150°C
 Storage Pressure.....1,378 kPa
 Acceleration (any axis, Un-powered for 0.5 msec)..50,000 g
 Acceleration (any axis, Powered for 0.5 msec).....50,000 g
 Output Short Circuit Duration, any pin to common.....Indefinite

*Stresses above those listed under Absolute Maximum Ratings may cause permanent damage to the device. This is a stress rating only; the functional operation of the device at these or any other conditions above those indicated in the operational sections of this specification is not implied. Exposure to absolute maximum rating conditions for extended periods may affect device reliability.

¹ Exposure for up to 60 minutes to absolute maximum ratings for supply voltages will not affect device reliability.

Package Characteristics

Package	θ_{JA}	θ_{JC}	Device Weight
LCC-8	110°C/W	22°C/W	< 1 gram

Ordering Guide

Model	Package Style
MXR7993VF	LCC-8 SMD*

* Parts are shipped in tape and reel packaging.

Caution

ESD (electrostatic discharge) sensitive device.

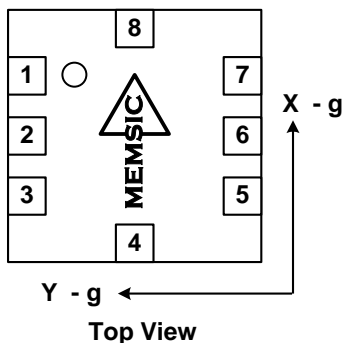

Note: The MEMSIC logo's arrow indicates the -X sensing direction of the device.
 The +Y sensing direction is rotated 90° away from the +X direction.
 Small circle indicates pin one (1).

Pin Description: LCC-8 Package

Pin	Name	Description
1	STIN	Self -Test Input
2	CLK	To be grounded. (Optional Serial Clock Input)
3	COM	Ground
4	NC	No Connect
5	NC	No Connect
6	YOUT	Y-Channel Ratiometric Output
7	XOUT	X-Channel Ratiometric Output
8	V_{DD}	Supply Voltage 3.0~3.6V

PIN DESCRIPTIONS

V_{DD} – (pin 8). Supply voltage input for digital and analog circuits.

For proper operation V_{DD} must be between 3.0~3.6V volts. Refer to the section on PCB layout and fabrication suggestions for guidance on external parts and connections recommended.

XOUT – (pin 7). X-axis acceleration signal output
 It is capable of sinking or sourcing up to 100 μ A. The user should ensure the load impedance is sufficiently high as to not source/sink >100 μ A.

YOUT – (pin 6) Y-axis acceleration signal output.
 It is capable of sinking or sourcing up to 100 μ A. The user should ensure the load impedance is sufficiently high as to not source/sink >100 μ A.

NC – (pin 5, 4) No connect. These pins can be tied to COM if the application does not allow pins to remain unconnected.

COM – (pin 3) This is the ground pin for the MXR7993VF
CLK – (pin 2) This is an optional serial clock input. The standard product is delivered with an internal clock (800 kHz). However, an external clock between 400 kHz and 1.6 MHz can be used as an option, if the sensor is programmed from the factory to run in external clock mode.

This pin is grounded internally with a 50 Kohm resistor if an external clock is used it should be able to drive this load. But if external clock is not used, in order to minimize noise and ESD this pin should be grounded externally as well.

STIN– (pin 1) Self –Test Input

This pin controls the self-test function of the sensor. Bringing STIN high will cause a negative deflection around 600mV to the AoutX AoutY from the 0g value.

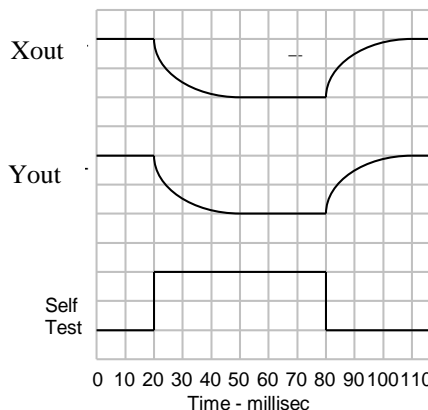

ESD Compliance:

The MXR7993VF sensor is in compliance with the following ESD standards:

Human Body and 2500V per AEC-Q100-002 Rev. E
Machine Model and 250V per AEC-Q100-003 Rev. E

Mounting Orientation:

The package orientation of the MXR7993VF does not affect the performance of the sensor. The specifications as stated in page 2 remain the same.

Thus, if the sensor is installed with one of its axis of sensitivity in the vertical plane, it detects accelerations in the Z-axis.



THEORY OF OPERATION

The MEMSIC device is a complete dual-axis acceleration measurement system fabricated on a monolithic CMOS IC process. The device operation is based on heat transfer by natural convection and operates like other accelerometers having a proof mass except it is a gas in the MEMSIC sensor.

A single heat source, centered in the silicon chip is suspended across a cavity. Equally spaced aluminum/polysilicon thermopiles (groups of thermocouples) are located equidistantly on all four sides of the heat source (dual axis). Under zero acceleration, a temperature gradient is symmetrical about the heat source, so that the temperature is the same at all four thermopiles, causing them to output the same voltage.

Acceleration in any direction will disturb the temperature profile, due to free convection heat transfer, causing it to be asymmetrical. The temperature, and hence voltage output of the four thermopiles will then be different. The differential voltage at the thermopile outputs is directly proportional to the acceleration. There are two identical acceleration signal paths on the MXR7993VF, one to measure acceleration in the x-axis and one to measure acceleration in the Y-axis. For more details visit the MEMSIC website at www.memsic.com for a picture/graphic description of the free convection heat transfer principle.

SELF-TEST DESCRIPTION

When Self-test is enabled the sensitivity compensation is turned off (disabled). With the sensitivity compensation disabled, the 1.0g offset voltages will double its value as compared with the zero g condition. With an exponent of

2.8 in the equation, the sensitivity will be $(298K / 233K)^{2.8} = 2.00$ times larger

The gas law governs the change in sensitivity over temperature.

All thermal accelerometers display the same sensitivity change with temperature. The sensitivity change depends on variations in heat transfer that are governed by the laws of physics. Manufacturing variations do not influence the sensitivity change, so there are no unit-to-unit differences in sensitivity change. The sensitivity change is governed by the following equation (and shown in Figure 1 in °C):

$$S_i \times T_i^{2.8} = S_f \times T_f^{2.8}$$

Where S_i is the sensitivity at any initial temperature T_i , and S_f is the sensitivity at any other final temperature T_f with the temperature values in °C.

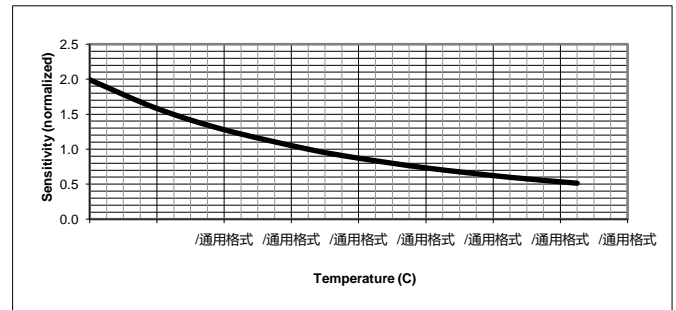

Figure 1: Thermal Accelerometer Sensitivity

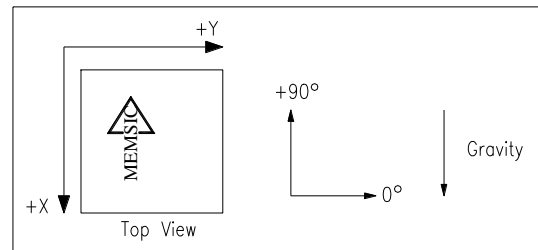

Figure 2: Accelerometer Position Relative to Gravity

Note1: When the temperature compensation is disabled and self-test is enabled. Self-test follows different gas law from sensitivity temperature dependence. It changes much smaller than sensitivity; this is why the temperature compensation is not done on self-test conditions.

Note2: Initial offset monitoring is a much better and reliable method to ensure sensor integrity, since it is ultra sensitive to sensor structure defect and damage. As long as initial offset is within specification the sensor is functioning correctly.

The sensor structure for the Thermal technology is guaranteed to fall outside the specified initial zero g offset parameters if the sensor is damaged or thermopile is failing. In most cases this will result in the output voltage hitting the rail at 3.3 volts.

PCB LAYOUT AND FABRICATION SUGGESTIONS

Reference Figure 3 and the notes below for recommendations on connecting a power source to the MEMSIC device and PCB fabrication.

Notes:

1. $C_1 = 0.2\mu\text{F}$
2. The capacitor should be located as close as possible to the device supply pin V_{DD} . Surface mount capacitors are preferred.
3. The CLK is grounded internally with a 50 kOhm resistor, however, in order to minimize noise and ESD this pin should be grounded externally as well.
4. Robust low inductance ground wiring should be used.
6. Care should be taken to ensure there is “thermal symmetry” on the PCB immediately surrounding the MEMSIC device and that there is no significant heat source nearby. This will minimize any errors in the measurement of acceleration.

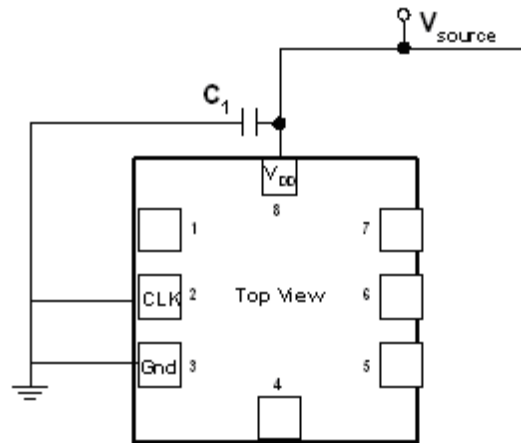
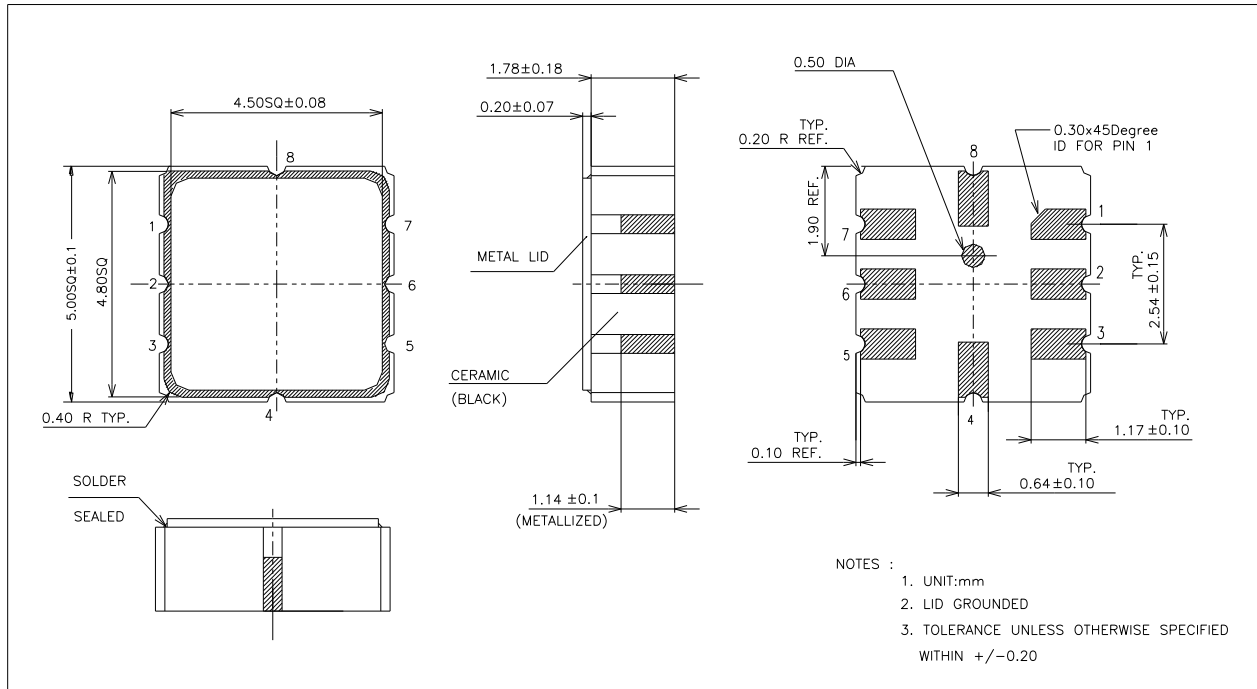

Figure 3: PCB Layout

MECHANICAL PACKAGE OUTLINE DIMENSIONS

Dimensions shown in mm.

LCC-8, Eight Pin, Hermetically Sealed, Surface Mount Package



Revision History

Version	Description of Content Change	Date
Rev. A	Revision A release for MP	2021/11/16